

countersunk flat head screws
 PK : slotted (DIN 963, NEN 2370, ISO 2009)
 PK-X: cross recessed (DIN 965, ISO 7046)

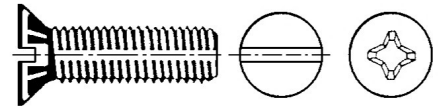

	quality A2 or A4	measure M	type	DIN norm	boxes of
B200012	SS-304	M 3x 25	PK	DIN 963	500
B200014	SS-304	M 3x 30	PK	DIN 963	500
B201105	SS-316	M 4x 10	PK-X	DIN 965	500
B201107	SS-316	M 4x 12	PK-X	DIN 965	500
B201109	SS-316	M 4x 16	PK-X	DIN 965	500
B201111	SS-316	M 4x 20	PK-X	DIN 965	500
B201113	SS-316	M 4x 25	PK-X	DIN 965	500
B201115	SS-316	M 4x 30	PK-X	DIN 965	500
B201121	SS-316	M 4x 40	PK-X	DIN 965	200
B201125	SS-316	M 4x 50	PK-X	DIN 965	200
B201131	SS-316	M 4x 60	PK-X	DIN 965	100
B201135	SS-316	M 4x 70	PK-X	DIN 965	100
B201206	SS-304	M 5x 12	PK-X	DIN 965	200
B200210	SS-304	M 5x 20	PK	DIN 963	500
B200212	SS-304	M 5x 25	PK	DIN 963	200
B201225	SS-316	M 5x 50	PK-X	DIN 965	200
B201230	SS-304	M 5x 60	PK-X	DIN 965	100
B201234	SS-304	M 5x 70	PK-X	DIN 965	100
B200304	SS-304	M 6x 10	PK	DIN 963	500
B200310	SS-304	M 6x 20	PK	DIN 963	500
B201312	SS-304	M 6x 25	PK-X	DIN 965	500
B200320	SS-304	M 6x 40	PK	DIN 963	200
B200420	SS-304	M 8x 40	PK	DIN 963	200
B200451	SS-316	M 8x100	PK	DIN 963	100
B200511	SS-316	M 10x 20	PK	DIN 963	100
B200531	SS-316	M 10x 60	PK	DIN 963	100
B200625	SS-316	M 12x 50	PK	DIN 963	50
B200641	SS-316	M 12x 80	PK	DIN 963	50

raised countersunk head screws
 LK : slotted (DIN 964, NEN 2371, ISO 2010)
 LK-X: cross recessed (DIN 966, ISO 7047)

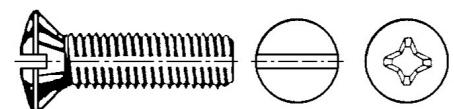

	quality A2 or A4	measure M	type	DIN norm	boxes of
B202204	SS-304	M 5x 10	LK	DIN 964	500
B203208	SS-304	M 5x 16	LK-X	DIN 966	500
B202216	SS-304	M 5x 35	LK	DIN 964	500
B202220	SS-304	M 5x 40	LK	DIN 964	500
B202224	SS-304	M 5x 50	LK	DIN 964	300
B203310	SS-304	M 6x 20	LK-X	DIN 966	300
B203320	SS-304	M 6x 40	LK-X	DIN 966	200
B203324	SS-304	M 6x 50	LK-X	DIN 966	100
B202410	SS-304	M 8x 20	LK	DIN 964	100

pan head screws
 CK : slotted (DIN 84, NEN 1602, ISO 1207)
 CK-X: cross recessed (DIN 7985, ISO 7045)

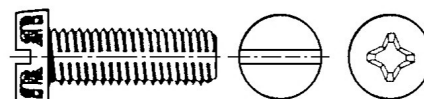

	quality A2 or A4	measure M	type	DIN norm	head (∅) mm	boxes of
B207001	SS-316	M 3x 6	CK-X	DIN 7985	6	500
B207009	SS-316	M 3x 16	CK-X	DIN 7985	6	500
B204012	SS-304	M 3x 25	CK	DIN 84	5,5	500
B204014	SS-304	M 3x 30	CK	DIN 84	5,5	500
B207101	SS-316	M 4x 6	CK-X	DIN 7985	8	500
B207105	SS-316	M 4x 10	CK-X	DIN 7985	8	500
B207109	SS-316	M 4x 16	CK-X	DIN 7985	8	500
B207111	SS-316	M 4x 20	CK-X	DIN 7985	8	500
B207113	SS-316	M 4x 25	CK-X	DIN 7985	8	500
B207115	SS-316	M 4x 30	CK-X	DIN 7985	8	500
B207121	SS-316	M 4x 40	CK-X	DIN 7985	8	500
B207209	SS-316	M 5x 16	CK-X	DIN 7985	10	250
B207211	SS-316	M 5x 20	CK-X	DIN 7985	10	500
B207212	SS-304	M 5x 25	CK-X	DIN 7985	10	500
B207215	SS-316	M 5x 30	CK-X	DIN 7985	10	500
B204230	SS-304	M 5x 60	CK	DIN 84	8,5	100
B204240	SS-304	M 5x 80	CK	DIN 84	8,5	100
B204250	SS-304	M 5x100	CK	DIN 84	8,5	100
B204304	SS-304	M 6x 10	CK	DIN 84	10	500
B204310	SS-304	M 6x 20	CK	DIN 84	10	500
B204314	SS-304	M 6x 30	CK	DIN 84	10	250
B207317	SS-316	M 6x 35	CK-X	DIN 7985	12	200
B207321	SS-316	M 6x 40	CK-X	DIN 7985	12	200
B204324	SS-304	M 6x 50	CK	DIN 84	10	200
B204331	SS-316	M 6x 60	CK	DIN 84	10	100
B204335	SS-316	M 6x 70	CK	DIN 84	10	100
B204340	SS-304	M 6x 80	CK	DIN 84	10	100
B204410	SS-304	M 8x 20	CK	DIN 84	13	100
B204414	SS-304	M 8x 30	CK	DIN 84	13	100
B204420	SS-304	M 8x 40	CK	DIN 84	13	100

hexagon socket head cap screws
 stainless steel 304/A2 or 316/A4
 DIN 912, NEN 1241, ISO 4762

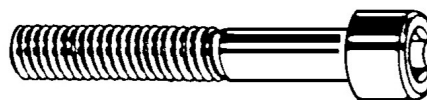

	quality A2 or A4	measure M	type	DIN norm	head (∅) mm	thread mm	boxes of
B222203	SS-316	M 5x 8	CK-I	DIN 912	8,5	7	200
B222205	SS-316	M 5x 10	CK-I	DIN 912	8,5	8	500
B222207	SS-316	M 5x 12	CK-I	DIN 912	8,5	10	500
B222209	SS-316	M 5x 16	CK-I	DIN 912	8,5	15	500
B222225	SS-316	M 5x 50	CK-I	DIN 912	8,5	23	40
B222345	SS-316	M 6x 90	CK-I	DIN 912	10	24	100
B222411	SS-316	M 8x 20	CK-I	DIN 912	13	17	100
B222451	SS-316	M 8x100	CK-I	DIN 912	13	29	100
B222632	SS-304	M 12x 65	CK-I	DIN 912	18	33	30

BOLTS, stainless steel

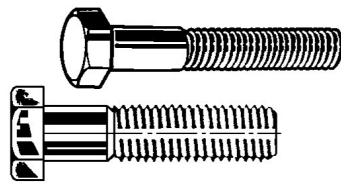

hexagon head screws
with partial thread
DIN 931, NEN 1555, ISO 4014

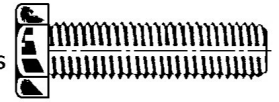

hexagon head screws
with full thread
DIN 933, NEN 1568, ISO 4017

	quality A2 or A4	measure M	type	DIN norm	sw mm	boxes of
B212035	SS-316	M 6x 12	full	DIN 933	10	200
B212045	SS-316	M 6x 16	full	DIN 933	10	200
B212055	SS-316	M 6x 20	full	DIN 933	10	200
B212065	SS-316	M 6x 25	full	DIN 933	10	200
B212104	SS-304	M 6x 40	full	DIN 933	10	200
B212134	SS-304	M 6x 50	full	DIN 933	10	200
B213065	SS-316	M 8x 25	full	DIN 933	13	100
B213084	SS-304	M 8x 30	full	DIN 933	13	100
B213105	SS-316	M 8x 40	full	DIN 933	13	100
B213154	SS-304	M 8x 60	full	DIN 933	13	100
B214055	SS-316	M 10x 20	full	DIN 933	17	100
B214135	SS-316	M 10x 50	full	DIN 933	17	50
B214205	SS-316	M 10x 80	full	DIN 933	17	50
B214393	SS-316	M 10x200	32mm	DIN 931	17	50
B215155	SS-316	M 12x 60	full	DIN 933	19	50
B215185	SS-316	M 12x 70	full	DIN 933	19	50
B215205	SS-316	M 12x 80	full	DIN 933	19	50
B215400	SS-304	M 12x160	36mm	DIN 931	19	25
B215509	SS-316	M 12x200	no	DIN 931-Z	19	25
B216105	SS-316	M 16x 40	full	DIN 933	24	25
B216205	SS-316	M 16x 80	full	DIN 933	24	25
B217084	SS-304	M 20x 30	full	DIN 933	30	25
B217104	SS-304	M 20x 40	full	DIN 933	30	25
B217154	SS-304	M 20x 60	full	DIN 933	30	25
B217250	SS-304	M 20x100	46mm	DIN 931	30	12
B217381	SS-316	M 20x150	52mm	DIN 931	30	12

thread rods
length = 1 meter
DIN 975/976, 2368

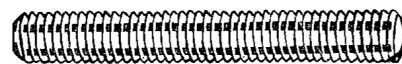

	quality A4	measure M	DIN norm	boxes of
B239031	SS-316	M 3x1000	DIN 975	10
B239041	SS-316	M 4x1000	DIN 975	10
B239051	SS-316	M 5x1000	DIN 975	10
B239061	SS-316	M 6x1000	DIN 975	10
B239081	SS-316	M 8x1000	DIN 975	10
B239101	SS-316	M 10x1000	DIN 975	10
B239121	SS-316	M 12x1000	DIN 975	10
B239161	SS-316	M 16x1000	DIN 975	5
B239201	SS-316	M 20x1000	DIN 975	5
B239241	SS-316	M 24x1000	DIN 975	5

hexagon socket head cap screws
stainless steel 304/A2 or 316/A4
DIN 912, NEN 1241, ISO 4762

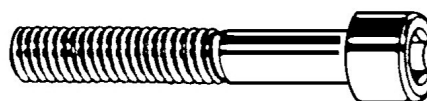

	quality A2 or A4	measure M	type	DIN norm	head (∅) mm	thread mm	boxes of
B222203	SS-316	M 5x 8	CK-I	DIN 912	8,5	7	200
B222205	SS-316	M 5x 10	CK-I	DIN 912	8,5	9	500
B222207	SS-316	M 5x 12	CK-I	DIN 912	8,5	11	500
B222209	SS-316	M 5x 16	CK-I	DIN 912	8,5	15	500
B222225	SS-316	M 5x 50	CK-I	DIN 912	8,5	23	30
B222345	SS-316	M 6x 90	CK-I	DIN 912	10	24	100
B222411	SS-316	M 8x 20	CK-I	DIN 912	13	17	100
B222451	SS-316	M 8x100	CK-I	DIN 912	13	28	100
B222632	SS-304	M 12x 65	CK-I	DIN 912	18	36	30

hexagon socket countersunk head screws
stainless steel 304/A2 or 316/A4
DIN 7991, ISO 10642

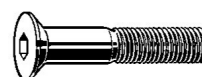

	quality A2 or A4	measure M	type	DIN norm	head (∅) mm	thread mm	boxes of
B223205	SS-316	M 5x 10	PK-I	DIN 7991	10		500
B201215	SS-316	M 5x 30	PK-TX	DIN 965-ISR-TORX			100

hexagon socket set screws with cup point
stainless steel 304/A2 or 316/A4
DIN 916, NEN 2343, ISO 4029



	quality A2 or A4	measure M	DIN norm	boxes of
B228103	SS-316	M 4x 4	DIN 916	(inside hexagon-2) 200
B228105	SS-316	M 4x 5	DIN 916	(inside hexagon-2) 200
B228111	SS-316	M 4x 10	DIN 916	(inside hexagon-2) 100
B228205	SS-316	M 5x 5	DIN 916	(inside hexagon-2,5) 200
B228213	SS-316	M 5x 12	DIN 916	(inside hexagon-2,5) 100
B228216	SS-304	M 5x 16	DIN 916	(inside hexagon-2,5) 100
B228236	SS-304	M 5x 35	DIN 916	(inside hexagon-2,5) 100
B228307	SS-316	M 6x 6	DIN 916	(inside hexagon-3) 100
B228350	SS-304	M 6x 50	DIN 916	(inside hexagon-3) 100
B228417	SS-316	M 8x 16	DIN 916	(inside hexagon-4) 100
B228421	SS-316	M 8x 20	DIN 916	(inside hexagon-4) 100
B228637	SS-316	M 12x 35	DIN 916	(inside hexagon-6) 100



PIMEX B.V.
Coenecoop 131
2741 PJ WADDINXVEEN (NL)
Tel. (31) 182 - 61 11 66
Email: info@pimex.nl

single ball catches
 stainless steel 303/1.4305 polished
 with stainless steel spring, not adjustable
 backside slotted, for maximum +250°C.

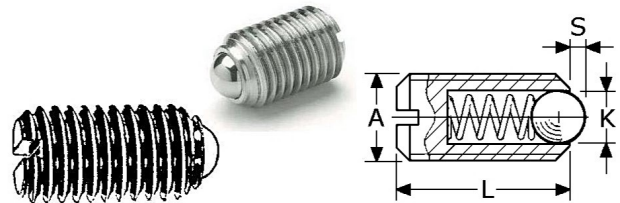

	quality 1.4305	measure A x L	spring	ball (ø) (K) mm	surface (S) mm	boxes of
B229504	SS-303	M 4x 9	8-14 N	2,5	0,8	100
B229505	SS-303	M 5x 12	8-14 N	3	0,9	20
B229506	SS-303	M 6x 14	11-16 N	3,5	1,5	20
B229508	SS-303	M 8x 16	18-31 N	5	1,5	20
B229510	SS-303	M 10x 19	24-45 N	6	2	20
B229512	SS-303	M 12x 22	26-49 N	8	2,5	100

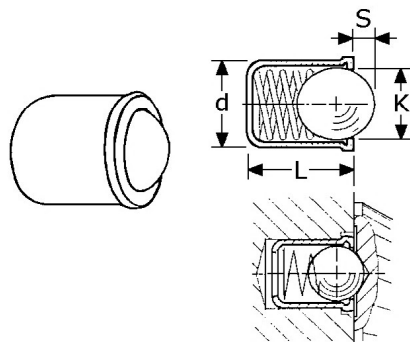

539208

single ball catches ø8x9mm
 stainless steel 303/1.4305 polished
 length (L) 9mm, for opening diameter (d) ø8mm
 with stainless steel spring, for maximum +250°C.
 stainless steel hardened ball (K) ø6,5mm, for 7-12 N
 ball surface (S) 1,9mm, backside closed
 in boxes of 20 Pcs.

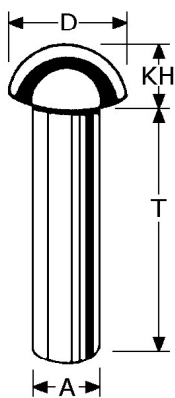

round head pins (rivets)
 stainless steel 304/A2 unpolished

	quality A2	measure A x T	D (mm)	KH head (mm)	boxes of
B230440	SS-304	4 x 40	7	2,2	100
B230550	SS-304	5 x 50	8,8	3	100
B230599	SS-304	5 x100	8,8	3	100
B230660	SS-304	6 x 64	10	4	100
B230676	SS-304	6 x 76	10	4	100
B230790	SS-304	7 x 89	11,8	4,5	100



PIMEX B.V.
 Coenecoop 131
 2741 PJ WADDINXVEEN (NL)
 Tel. (31) 182 - 61 11 66
 Email: info@pimex.nl

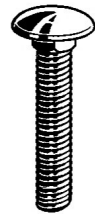

mushroom head square neck bolts
stainless steel 304/A2 or 316/A4
DIN 603, NEN 303, ISO 8677

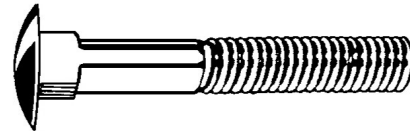

	quality A2 or A4	measure M	type	DIN norm	head (ø) mm	thread mm	boxes of
B220241	SS-316	M 5x 80	full	DIN 603	13,5	70	200
B220313	SS-316	M 6x 25	full	DIN 603	16,5	20	200
B220320	SS-304	M 6x 40	full	DIN 603	16,5	32	100
B220324	SS-304	M 6x 50	full	DIN 603	16,5	42	100
B220330	SS-304	M 6x 60		DIN 603	16,5	18	100
B220340	SS-304	M 6x 80	full	DIN 603	16,5	72	100
B220410	SS-304	M 8x 20	full	DIN 603	20,6	11	100
B220416	SS-304	M 8x 35	full	DIN 603	20,6	26	100
B220420	SS-304	M 8x 40	full	DIN 603	20,6	31	100
B220425	SS-316	M 8x 50	full	DIN 603	20,6	41	25
B220431	SS-316	M 8x 60	full	DIN 603	20,6	51	25
B220451	SS-316	M 8x100	full	DIN 603	20,6	91	25
B220454	SS-304	M 8x110		DIN 603	20,6	55	25
B220530	SS-304	M 10x 60	full	DIN 603	24,6	50	25

thread rods
length = 1 meter
DIN 975/976, NEN 2368



	quality A4	measure M	DIN norm	boxes of
B239031	SS-316	M 3x1000	DIN 975	10
B239041	SS-316	M 4x1000	DIN 975	10
B239051	SS-316	M 5x1000	DIN 975	10
B239061	SS-316	M 6x1000	DIN 975	10
B239081	SS-316	M 8x1000	DIN 975	10
B239101	SS-316	M 10x1000	DIN 975	10
B239121	SS-316	M 12x1000	DIN 975	10
B239161	SS-316	M 16x1000	DIN 975	5
B239201	SS-316	M 20x1000	DIN 975	5
B239241	SS-316	M 24x1000	DIN 975	5



PIMEX B.V.
Coenecoop 131
2741 PJ WADDINXVEEN (NL)
Tel. (31) 182 - 61 11 66
Email: info@pimex.nl