

kolomschroeven met platverzonken kop
 PK : met zaagsnede (DIN 963, NEN 2370, ISO 2009)
 PK-X: met pozidriv kruiskop (DIN 965, ISO 7046)

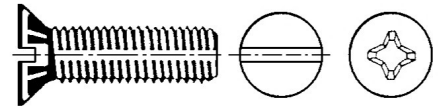

	kwaliteit A2 of A4	maat	type	DIN norm	verpakt per
B200012	RVS-304	M 3x 25	PK	DIN 963	500
B200014	RVS-304	M 3x 30	PK	DIN 963	500
B201105	RVS-316	M 4x 10	PK-X	DIN 965	500
B201107	RVS-316	M 4x 12	PK-X	DIN 965	500
B201109	RVS-316	M 4x 16	PK-X	DIN 965	500
B201111	RVS-316	M 4x 20	PK-X	DIN 965	500
B201113	RVS-316	M 4x 25	PK-X	DIN 965	500
B201115	RVS-316	M 4x 30	PK-X	DIN 965	500
B201121	RVS-316	M 4x 40	PK-X	DIN 965	200
B201125	RVS-316	M 4x 50	PK-X	DIN 965	200
B201131	RVS-316	M 4x 60	PK-X	DIN 965	100
B201135	RVS-316	M 4x 70	PK-X	DIN 965	100
B201206	RVS-304	M 5x 12	PK-X	DIN 965	200
B200210	RVS-304	M 5x 20	PK	DIN 963	500
B200212	RVS-304	M 5x 25	PK	DIN 963	200
B201225	RVS-316	M 5x 50	PK-X	DIN 965	200
B201230	RVS-304	M 5x 60	PK-X	DIN 965	100
B201234	RVS-304	M 5x 70	PK-X	DIN 965	100
B200304	RVS-304	M 6x 10	PK	DIN 963	500
B200310	RVS-304	M 6x 20	PK	DIN 963	500
B201312	RVS-304	M 6x 25	PK-X	DIN 965	500
B200320	RVS-304	M 6x 40	PK	DIN 963	200
B200420	RVS-304	M 8x 40	PK	DIN 963	200
B200451	RVS-316	M 8x100	PK	DIN 963	100
B200511	RVS-316	M 10x 20	PK	DIN 963	100
B200531	RVS-316	M 10x 60	PK	DIN 963	100
B200625	RVS-316	M 12x 50	PK	DIN 963	50
B200641	RVS-316	M 12x 80	PK	DIN 963	50

ook te leveren: - andere maten (levering op aanvraag)

kolomschroeven met bolverzonken- of lenskop
 LK : met zaagsnede (DIN 964, NEN 2371, ISO 2010)
 LK-X: met pozidriv kruiskop (DIN 966, ISO 7047)

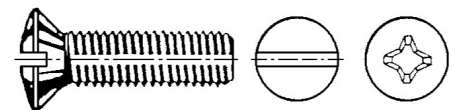

	kwaliteit A2 of A4	maat	type	DIN norm	verpakt per
B202204	RVS-304	M 5x 10	LK	DIN 964	500
B203208	RVS-304	M 5x 16	LK-X	DIN 966	500
B202216	RVS-304	M 5x 35	LK	DIN 964	500
B202220	RVS-304	M 5x 40	LK	DIN 964	500
B202224	RVS-304	M 5x 50	LK	DIN 964	300
B203310	RVS-304	M 6x 20	LK-X	DIN 966	300
B203320	RVS-304	M 6x 40	LK-X	DIN 966	200
B203324	RVS-304	M 6x 50	LK-X	DIN 966	100
B202410	RVS-304	M 8x 20	LK	DIN 964	100

kolomschroeven met cilinderkop

CK : met zaagsnede (DIN 84, NEN 1602, ISO 1207)

CK-X: met pozidriv kruiskop (DIN 7985, ISO 7045)

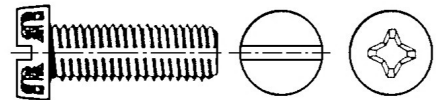

	kwaliteit A2 of A4	maat	type	DIN norm	kopdiameter mm	verpakt per
B207001	RVS-316	M 3x 6	CK-X	DIN 7985	6	500
B207009	RVS-316	M 3x 16	CK-X	DIN 7985	6	500
B204012	RVS-304	M 3x 25	CK	DIN 84	5,5	500
B204014	RVS-304	M 3x 30	CK	DIN 84	5,5	500
B207101	RVS-316	M 4x 6	CK-X	DIN 7985	8	500
B207105	RVS-316	M 4x 10	CK-X	DIN 7985	8	500
B207109	RVS-316	M 4x 16	CK-X	DIN 7985	8	500
B207111	RVS-316	M 4x 20	CK-X	DIN 7985	8	500
B207113	RVS-316	M 4x 25	CK-X	DIN 7985	8	500
B207115	RVS-316	M 4x 30	CK-X	DIN 7985	8	500
B207121	RVS-316	M 4x 40	CK-X	DIN 7985	8	500
B207209	RVS-316	M 5x 16	CK-X	DIN 7985	10	250
B207211	RVS-316	M 5x 20	CK-X	DIN 7985	10	500
B207212	RVS-304	M 5x 25	CK-X	DIN 7985	10	500
B207215	RVS-316	M 5x 30	CK-X	DIN 7985	10	500
B204230	RVS-304	M 5x 60	CK	DIN 84	8,5	100
B204240	RVS-304	M 5x 80	CK	DIN 84	8,5	100
B204250	RVS-304	M 5x100	CK	DIN 84	8,5	100
B204304	RVS-304	M 6x 10	CK	DIN 84	10	500
B204310	RVS-304	M 6x 20	CK	DIN 84	10	500
B204314	RVS-304	M 6x 30	CK	DIN 84	10	250
B207317	RVS-316	M 6x 35	CK-X	DIN 7985	12	200
B207321	RVS-316	M 6x 40	CK-X	DIN 7985	12	200
B204324	RVS-304	M 6x 50	CK	DIN 84	10	200
B204331	RVS-316	M 6x 60	CK	DIN 84	10	100
B204335	RVS-316	M 6x 70	CK	DIN 84	10	100
B204340	RVS-304	M 6x 80	CK	DIN 84	10	100
B204410	RVS-304	M 8x 20	CK	DIN 84	13	100
B204414	RVS-304	M 8x 30	CK	DIN 84	13	100
B204420	RVS-304	M 8x 40	CK	DIN 84	13	100

inbusbouten, kolomschroeven met inbus
cilinderkop met binnenzeskant
DIN 912, NEN 1241, ISO 4762

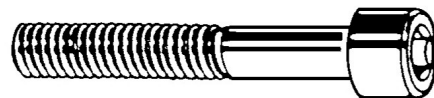

	kwaliteit A2 of A4	maat	type	DIN norm	kopdiameter mm	draadlengte mm	verpakt per
B222203	RVS-316	M 5x 8	CK-I	DIN 912	8,5	7	200
B222205	RVS-316	M 5x 10	CK-I	DIN 912	8,5	8	500
B222207	RVS-316	M 5x 12	CK-I	DIN 912	8,5	10	500
B222209	RVS-316	M 5x 16	CK-I	DIN 912	8,5	15	500
B222225	RVS-316	M 5x 50	CK-I	DIN 912	8,5	23	40
B222345	RVS-316	M 6x 90	CK-I	DIN 912	10	24	100
B222411	RVS-316	M 8x 20	CK-I	DIN 912	13	17	100
B222451	RVS-316	M 8x100	CK-I	DIN 912	13	29	100
B222632	RVS-304	M 12x 65	CK-I	DIN 912	18	33	30

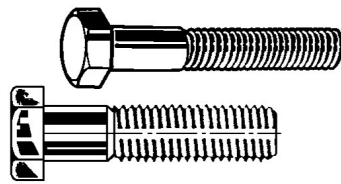

zeskantbouten
met gedeeltelijk draad
DIN 931, NEN 1555, ISO 4014

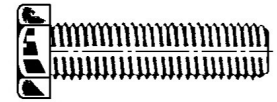

zeskanttapbouten
met volle draad
DIN 933, NEN 1568, ISO 4017

	kwaliteit A2 of A4	maat	type	DIN norm	sleutelwijdte mm	verpakt per
B212035	RVS-316	M 6x 12	vol	DIN 933	10	200
B212045	RVS-316	M 6x 16	vol	DIN 933	10	200
B212055	RVS-316	M 6x 20	vol	DIN 933	10	200
B212065	RVS-316	M 6x 25	vol	DIN 933	10	200
B212104	RVS-304	M 6x 40	vol	DIN 933	10	200
B212134	RVS-304	M 6x 50	vol	DIN 933	10	200
B213065	RVS-316	M 8x 25	vol	DIN 933	13	100
B213084	RVS-304	M 8x 30	vol	DIN 933	13	100
B213105	RVS-316	M 8x 40	vol	DIN 933	13	100
B213154	RVS-304	M 8x 60	vol	DIN 933	13	100
B214055	RVS-316	M 10x 20	vol	DIN 933	17	100
B214135	RVS-316	M 10x 50	vol	DIN 933	17	50
B214205	RVS-316	M 10x 80	vol	DIN 933	17	50
B214393	RVS-316	M 10x200	32mm	DIN 931	17	50
B215155	RVS-316	M 12x 60	vol	DIN 933	19	50
B215185	RVS-316	M 12x 70	vol	DIN 933	19	50
B215205	RVS-316	M 12x 80	vol	DIN 933	19	50
B215400	RVS-304	M 12x160	36mm	DIN 931	19	25
B215509	RVS-316	M 12x200	zonder	DIN 931-Z	19	25
B216105	RVS-316	M 16x 40	vol	DIN 933	24	25
B216205	RVS-316	M 16x 80	vol	DIN 933	24	25
B217084	RVS-304	M 20x 30	vol	DIN 933	30	25
B217104	RVS-304	M 20x 40	vol	DIN 933	30	25
B217154	RVS-304	M 20x 60	vol	DIN 933	30	25
B217250	RVS-304	M 20x100	46mm	DIN 931	30	12
B217381	RVS-316	M 20x150	52mm	DIN 931	30	12

draadeinden
lengten van 1 meter
DIN 975, NEN 2368

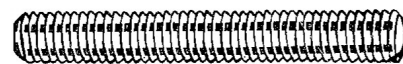

	kwaliteit A2 of A4	maat	DIN norm	verpakt per
B239031	RVS-316	M 3x1000	DIN 975	10
B239041	RVS-316	M 4x1000	DIN 975	10
B239051	RVS-316	M 5x1000	DIN 975	10
B239061	RVS-316	M 6x1000	DIN 975	10
B239081	RVS-316	M 8x1000	DIN 975	10
B239101	RVS-316	M 10x1000	DIN 975	10
B239121	RVS-316	M 12x1000	DIN 975	10
B239161	RVS-316	M 16x1000	DIN 975	5
B239201	RVS-316	M 20x1000	DIN 975	5
B239241	RVS-316	M 24x1000	DIN 975	5

inbusbouten, kolomschroeven met inbus
cilinderkop met binnenzeskant
DIN 912, NEN 1241, ISO 4762

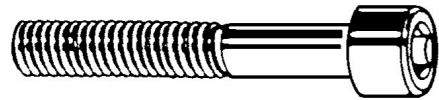

	kwaliteit A2 of A4	maat	type	DIN norm	kopdiameter mm	draadlengte mm	verpakt per
B222203	RVS-316	M 5x 8	CK-I	DIN 912	8,5	7	200
B222205	RVS-316	M 5x 10	CK-I	DIN 912	8,5	9	500
B222207	RVS-316	M 5x 12	CK-I	DIN 912	8,5	11	500
B222209	RVS-316	M 5x 16	CK-I	DIN 912	8,5	15	500
B222225	RVS-316	M 5x 50	CK-I	DIN 912	8,5	23	30
B222345	RVS-316	M 6x 90	CK-I	DIN 912	10	24	100
B222411	RVS-316	M 8x 20	CK-I	DIN 912	13	17	100
B222451	RVS-316	M 8x100	CK-I	DIN 912	13	28	100
B222632	RVS-304	M 12x 65	CK-I	DIN 912	18	36	30

inbusbouten, kolomschroeven met inbus
platverzonken kop met binnenzeskant
DIN 7991, ISO 10642

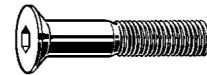

	kwaliteit A2 of A4	maat	type	DIN norm	kopdiameter mm	verpakt per
B223205	RVS-316	M 5x 10	PK-I	DIN 7991	10	500
B201215	RVS-316	M 5x 30	PK-TX	DIN 965-ISR-TORX		100

stelschroeven
met inwendig zeskant/inbus
DIN 916, NEN 2343, ISO 4029

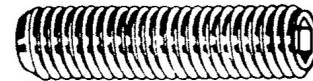

	kwaliteit A2 of A4	maat	DIN norm	verpakt per
B228103	RVS-316	M 4x 4	DIN 916 (binnenzeskant inbus-2)	200
B228105	RVS-316	M 4x 5	DIN 916 (binnenzeskant inbus-2)	200
B228111	RVS-316	M 4x 10	DIN 916 (binnenzeskant inbus-2)	100
B228205	RVS-316	M 5x 5	DIN 916 (binnenzeskant inbus-2,5)	200
B228213	RVS-316	M 5x 12	DIN 916 (binnenzeskant inbus-2,5)	100
B228216	RVS-304	M 5x 16	DIN 916 (binnenzeskant inbus-2,5)	100
B228236	RVS-304	M 5x 35	DIN 916 (binnenzeskant inbus-2,5)	100
B228307	RVS-316	M 6x 6	DIN 916 (binnenzeskant inbus-3)	100
B228350	RVS-304	M 6x 50	DIN 916 (binnenzeskant inbus-3)	100
B228417	RVS-316	M 8x 16	DIN 916 (binnenzeskant inbus-4)	100
B228421	RVS-316	M 8x 20	DIN 916 (binnenzeskant inbus-4)	100
B228637	RVS-316	M 12x 35	DIN 916 (binnenzeskant inbus-6)	100



PIMEX B.V.
Coenecoop 131
2741 PJ WADDINXVEEN (NL)
Tel. (31) 182 - 61 11 66
Email: info@pimex.nl

drukstukken met kogel verend, met geharde roestvrijstalen kogel met RVS veer, hittebestendig tot 250°C. met zaagsnede aan achterzijde

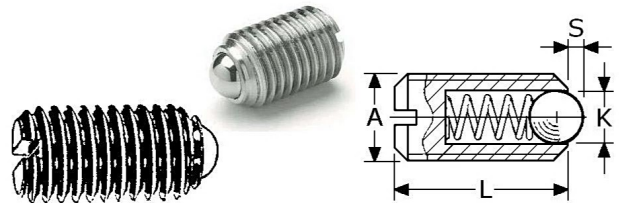

	kwaliteit 1.4305	maat A x L	druk	kogeldiameter (K) mm	steekt uit (S) mm	verpakt per
B229504	RVS-303	M 4x 9	8-14 N	2,5	0,8	100
B229505	RVS-303	M 5x 12	8-14 N	3	0,9	20
B229506	RVS-303	M 6x 14	11-16 N	3,5	1,5	20
B229508	RVS-303	M 8x 16	18-31 N	5	1,5	20
B229510	RVS-303	M 10x 19	24-45 N	6	2	20
B229512	RVS-303	M 12x 22	26-49 N	8	2,5	100



ook te leveren:
- drukstukken met binnenzeskant (BR2292..) (levering op aanvraag)

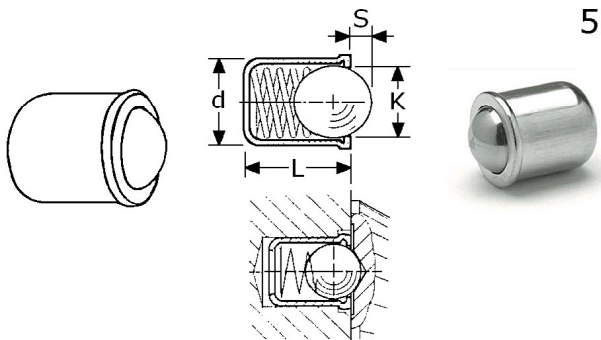

539208

inboorkogelsnappers ø8x9mm
huls roestvrijstaal 303/1.4305, dikte (D) ø8mm met geharde RVS kogel (K) ø6,5mm lengte (L) 9mm, kogel steekt (S) 1,9mm uit voorzien van RVS veer (druk 7-12 N) geschikt voor -30° tot +250°C. verpakt per 20 stuks

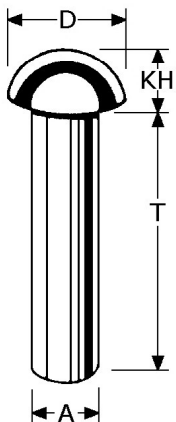

ronde pennen/klinknagels (DIN 660)

	kwaliteit A2	maat A x T	D (mm)	KH (mm) kop	verpakt per
B230440	RVS-304	4 x 40	7	2,2	100
B230550	RVS-304	5 x 50	8,8	3	100
B230599	RVS-304	5 x 100	8,8	3	100
B230660	RVS-304	6 x 64	10	4	100
B230676	RVS-304	6 x 76	10	4	100
B230790	RVS-304	7 x 89	11,8	4,5	100

B232508

blindklinknagels, maat 4,8x7,6mm roestvrijstaal 305 lengte 7,6mm, maximum klink 3,2mm platbolkop, met RVS trekpen verpakt per 1000 stuks (levering op aanvraag)



PIMEX B.V.
Coenecoop 131
2741 PJ WADDINXVEEN (NL)
Tel. (31) 182 - 61 11 66
Email: info@pimex.nl

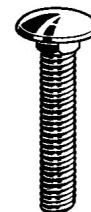

slotbouten
met vierkant onder de half-ronde kop
DIN 603, NEN 303, ISO 8677

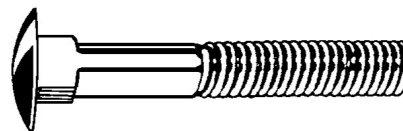

	kwaliteit A2 of A4	maat	type	DIN norm	kopdiameter mm	draadlengte mm	verpakt per
B220241	RVS-316	M 5x 80	vol	DIN 603	13,5	70	200
B220313	RVS-316	M 6x 25	vol	DIN 603	16,5	20	200
B220320	RVS-304	M 6x 40	vol	DIN 603	16,5	32	100
B220324	RVS-304	M 6x 50	vol	DIN 603	16,5	42	100
B220330	RVS-304	M 6x 60		DIN 603	16,5	18	100
B220340	RVS-304	M 6x 80	vol	DIN 603	16,5	72	100
B220410	RVS-304	M 8x 20	vol	DIN 603	20,6	11	100
B220416	RVS-304	M 8x 35	vol	DIN 603	20,6	26	100
B220420	RVS-304	M 8x 40	vol	DIN 603	20,6	31	100
B220425	RVS-316	M 8x 50	vol	DIN 603	20,6	41	25
B220431	RVS-316	M 8x 60	vol	DIN 603	20,6	51	25
B220451	RVS-316	M 8x100	vol	DIN 603	20,6	91	25
B220454	RVS-304	M 8x110		DIN 603	20,6	55	25
B220530	RVS-304	M 10x 60	vol	DIN 603	24,6	50	25

draadeinden
lengten van 1 meter
DIN 975, NEN 2368



	kwaliteit A2 of A4	maat	DIN norm	verpakt per
B239031	RVS-316	M 3x1000	DIN 975	10
B239041	RVS-316	M 4x1000	DIN 975	10
B239051	RVS-316	M 5x1000	DIN 975	10
B239061	RVS-316	M 6x1000	DIN 975	10
B239081	RVS-316	M 8x1000	DIN 975	10
B239101	RVS-316	M 10x1000	DIN 975	10
B239121	RVS-316	M 12x1000	DIN 975	10
B239161	RVS-316	M 16x1000	DIN 975	5
B239201	RVS-316	M 20x1000	DIN 975	5
B239241	RVS-316	M 24x1000	DIN 975	5



PIMEX B.V.
Coenecoop 131
2741 PJ WADDINXVEEN (NL)
Tel. (31) 182 - 61 11 66
Email: info@pimex.nl