

application

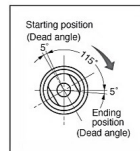

460205



hinges $\varnothing 20\text{mm}$ with soft-closing dampening stainless steel 304/A2 (marked with blue point) with white plastic shaft (UDH-AMS) dampening direction: counter clockwise with torque 15-25 Kgf/cm (friction not adjustable) the hinge can be used for $0^{\circ}\text{C. till } +40^{\circ}\text{C.}$ total length 55mm, for build in, maximum hook 115° from $115^{\circ}-80^{\circ}$ only working with enough gravity in boxes of 20 Pcs.

460206



hinges $\varnothing 20\text{mm}$ with soft-closing dampening stainless steel 304/A2 (marked with blue point) with grey plastic shaft (UDH-BMS) dampening direction: clockwise with torque 15-25 Kgf/cm (friction not adjustable) the hinge can be used for $0^{\circ}\text{C. till } +40^{\circ}\text{C.}$ total length 55mm, for build in, maximum hook 115° from $115^{\circ}-80^{\circ}$ only working with enough gravity in boxes of 20 Pcs.

460207



hinges $\varnothing 20\text{mm}$ with soft-closing dampening stainless steel 304/A2 (marked with red point) with white plastic shaft (UDH-AHS) dampening direction: counter clockwise with torque 25-35 Kgf/cm (friction not adjustable) the hinge can be used for $0^{\circ}\text{C. till } +40^{\circ}\text{C.}$ total length 55mm, for build in, maximum hook 115° from $115^{\circ}-80^{\circ}$ only working with enough gravity in boxes of 20 Pcs.

460208



hinges $\varnothing 20\text{mm}$ with soft-closing dampening stainless steel 304/A2 (marked with red point) with grey plastic shaft (UDH-BHS) dampening direction: clockwise with torque 25-35 Kgf/cm (friction not adjustable) the hinge can be used for $0^{\circ}\text{C. till } +40^{\circ}\text{C.}$ total length 55mm, for build in, maximum hook 115° from $115^{\circ}-80^{\circ}$ only working with enough gravity in boxes of 20 Pcs.

460247



hinges $\varnothing 14\text{mm}$ with soft-closing dampening stainless steel 304/A2 (marked with red point) with white plastic shaft (UDH-14-AHS) dampening direction: counter clockwise with torque 15-25 Kgf/cm (friction not adjustable) the hinge can be used for $0^{\circ}\text{C. till } +40^{\circ}\text{C.}$ total length 37mm, for build in, maximum hook 115° from $115^{\circ}-80^{\circ}$ only working with enough gravity in boxes of 20 Pcs.

460248



hinges $\varnothing 14\text{mm}$ with soft-closing dampening stainless steel 304/A2 (marked with red point) with grey plastic shaft (UDH-14-BHS) dampening direction: clockwise with torque 15-25 Kgf/cm (friction not adjustable) the hinge can be used for $0^{\circ}\text{C. till } +40^{\circ}\text{C.}$ total length 37mm, for build in, maximum hook 115° from $115^{\circ}-80^{\circ}$ only working with enough gravity in boxes of 20 Pcs.



PIMEX B.V.
Coenecoop 131
2741 PJ WADDINXVEEN (NL)
Tel. (31) 182 - 61 11 66
Email: info@pimex.nl

HINGES WITH SOFT-CLOSING



387251

hinges 46x100mm with soft-closing dampening stainless steel 304/316 mirror polished
 hinge-A: with build in white plastic shaft
 dampening direction: counter clockwise
 hinge-B: with build in grey plastic shaft
 dampening direction: clockwise
 with torque 30-51 kgf/cm (friction not adjustable)
 the hinge can be used from 0°C. till +40°C.
 surface mounting maximum hook 115°
 from 115°-80° only working with enough gravity
 knuckle $\varnothing 20\text{mm}$, total highness 21mm
 leaves 18x50mm, leaf thickness 9mm
 with each 2+2 countersunked screwholes (5mm)
 sold in pairs

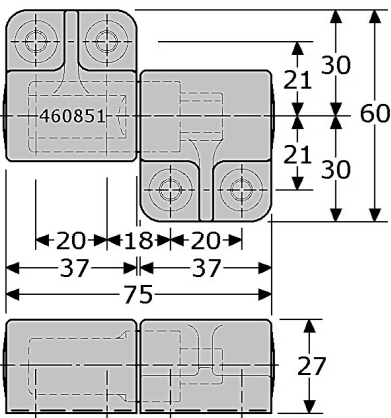
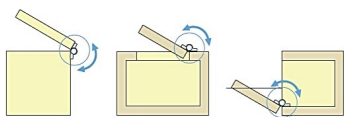
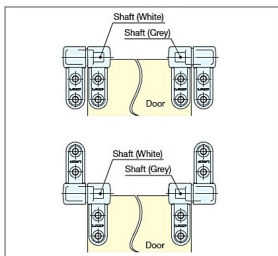
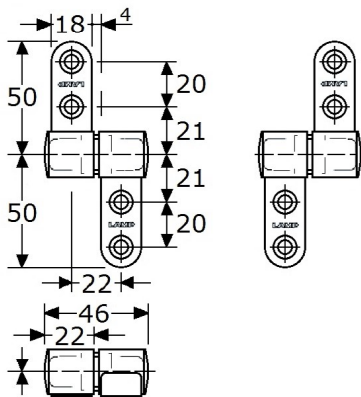
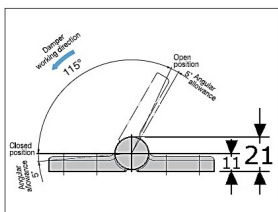

460851

hinges 75x60mm with soft-closing dampening black polypropylene with stainless steel damper
 hinge-A: with build in white plastic shaft
 dampening direction: counter clockwise
 hinge-B: with build in grey plastic shaft
 dampening direction: clockwise
 with torque 30-51 kgf/cm (friction not adjustable)
 the hinge can be used from 0°C. till +40°C.
 surface mounting maximum hook 115°
 from 115°-80° only working with enough gravity
 knuckle $\varnothing 26\text{mm}$, total highness 27mm
 leaves 37x30mm, leaf thickness 11mm
 with each 2+2 lower screwholes $\varnothing 5,4\text{mm}$
 sold in pairs

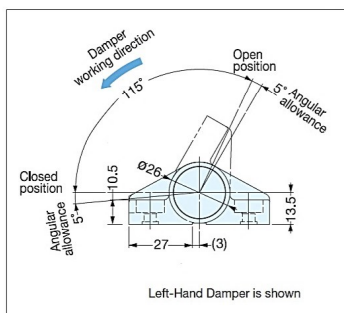
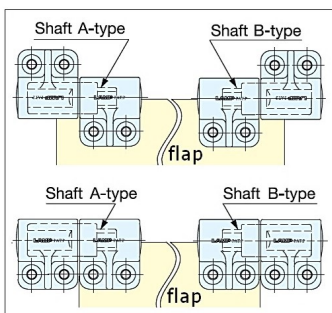

PIMEX B.V.
 Coenecoop 131
 2741 PJ WADDINXVEEN (NL)
 Tel. (31) 182 - 61 11 66
 Email: info@pimex.nl

HINGES WITH SOFT-CLOSING



460870

hinge 115x72mm
 black polypropylene with stainless steel damper
 top opening, surface mounting
 with torque 102-143 Kgf/cm (friction not adjustable)
 the hinge can be used for 0°C. till 40°C.
 working only from 115° till 0° full flat
 from 115°-60° only working with enough gravity
 knuckle $\varnothing 26$ mm, total highness 26,5mm
 leaf thickness 10,5mm
 with each 2+2 lower screwholes (5mm/M5)
 in boxes of 4 Pcs.

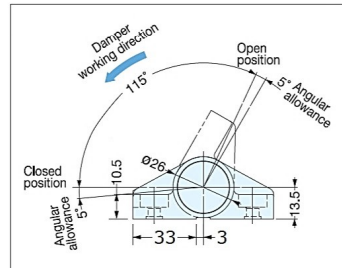
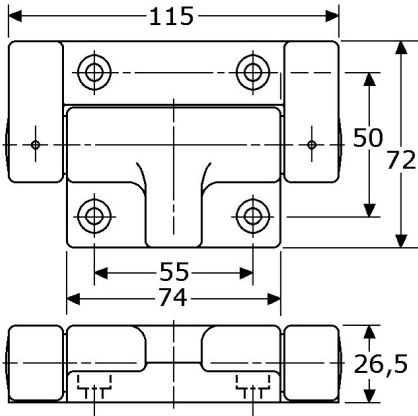

460820

hinge 150x201mm
 body stainless steel 430
 with big light-grey plastic covers
 top opening, surface mounting
 with torque 145-161 Kgf/cm (friction adjustable)
 the hinge can be used for 0°C. till 40°C.
 opening from 0° to 90° lift assist
 (spring loaded for extra light opening)
 from 90° to 100°: free zone, no damping
 from 90° to 20° free stop
 (torque hold flap at any point)
 from 20° to 0° with EasyClose softclosing
 (smooth and soft downward movement)
 all screwholes behind the covers
 in boxes of 1 Pcs. (delivery on request)

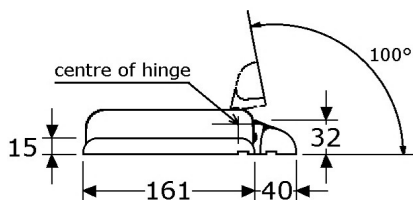
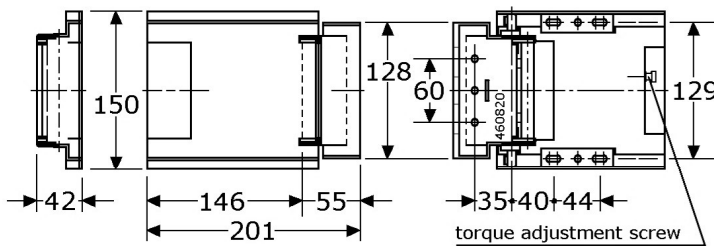
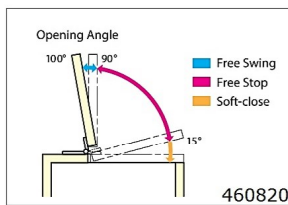

also stronger possible:
 - with torque 194-214 Kgf/cm (460821)
 - with torque 245-265 Kgf/cm (460822)

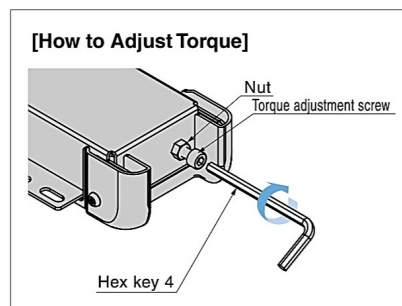

PIMEX B.V.
 Coenecoop 131
 2741 PJ WADDINXVEEN (NL)
 Tel. (31) 182 - 61 11 66
 Email: info@pimex.nl

HINGES

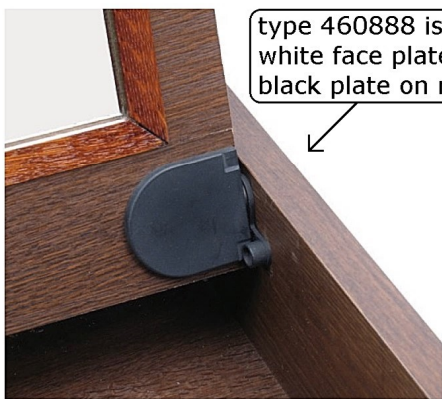

type 460888 is with white face plate; black plate on request

460888

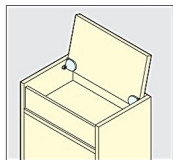

hinges for top opening flap doors with soft-closing black plastic with stainless steel UDH-16 damper
 hinge-A: with build in white plastic shaft
 dampening direction: counter clockwise
 hinge-B: with build in grey plastic shaft
 dampening direction: clockwise
 with torque 34-50 kgf/cm (friction not adjustable)
 the hinge can be used from 0°C. till +40°C.
 soft-closing, stop on 105°
 from 105°-80° only working with enough gravity
 for build in, thickness mechanism 16mm
 with white plastic face plate 50x53mm, rounded
 with black mounting plate LH for white damper-A
 with black mounting plate RH for grey damper-B
 sold in pairs

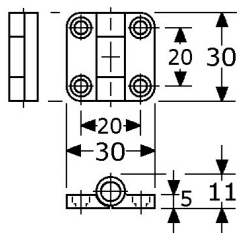
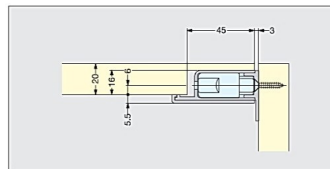
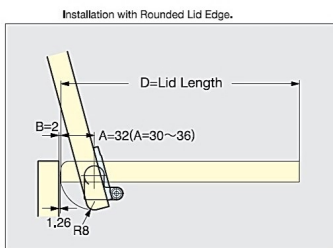
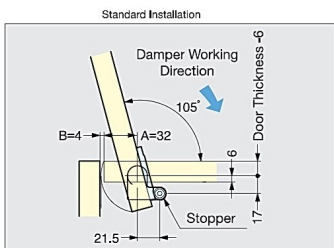

461801

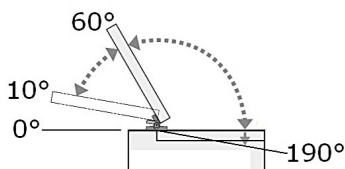

detent hinges 30x30x5mm
 white polyamide (PA)
 without spring, holds door in 3 different positions:
 with blocking on +10°, +60° and +190°
 with extra power on +180° to push to +190°
 3-knuckles $\varnothing 9,5$ mm, fixed pin, total highness 11mm
 with 4 lower screwholes $\varnothing 4,2$ mm
 in boxes of 20 Pcs. (delivery on request)

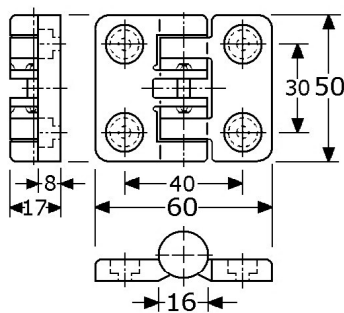

461848

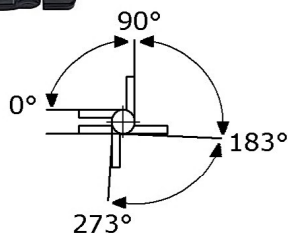

detent hinges 50x60x8mm
 black polyamide (PA)
 without spring, holds door in 4 different positions:
 with blocking on 0°, +90°, +183° and +273°
 with fixed stainless steel pin $\varnothing 4,5$ mm
 4-knuckles $\varnothing 16$ mm, total highness 17mm
 with 4 lower screwholes $\varnothing 4,2$ mm
 with 4 black plastic covers $\varnothing 13$ mm ●●●●
 in boxes of 20 Pcs.

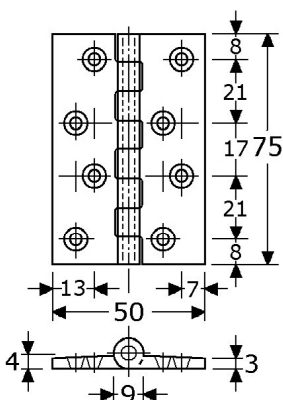

469817

hinges 75x50mm
 natural-nylon
 thickness from 3mm till 4mm
 with fixed stainless steel pin $\varnothing 4$ mm
 8-knuckles $\varnothing 9$ mm, highness 9mm
 with 8 countersunk screwholes (4mm/M4)
 in boxes of 20 Pcs.



PIMEX B.V.
 Coenecoop 131
 2741 PJ WADDINXVEEN (NL)
 Tel. (31) 182 - 61 11 66
 Email: info@pimex.nl

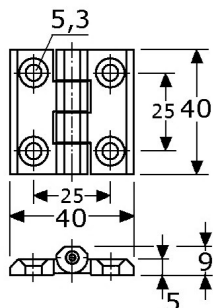

462810

hinges 40x40x5mm
black polyamide (PA)
with fixed stainless steel pin \varnothing 4mm
4-knuckles, highness 9mm, smooth border
with 4 countersunk screwholes (5mm/M5)
in boxes of 20 Pcs.

for hinges in stainless steel (329259),
see page GY-323b (group 03)

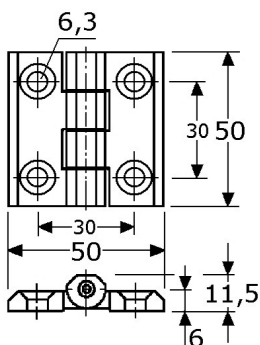

462812

hinges 50x50x6mm
black polyamide (PA)
with fixed stainless steel pin \varnothing 6mm
4-knuckles, highness 11,5mm, smooth border
with 4 countersunk screwholes (6mm/M6)
in boxes of 100 Pcs. (delivery on request)

for hinges in stainless steel (329264),
see page GY-323b (group 03)

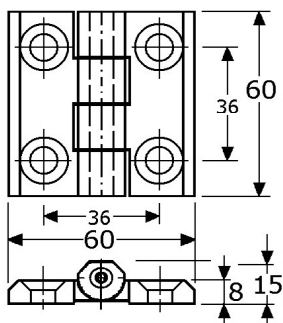

462816

hinges 60x60x8mm
black polyamide (PA)
with fixed stainless steel pin \varnothing 8mm
4-knuckles, highness 15mm, smooth border
with 4 countersunk screwholes (8mm/M8)
in boxes of 20 Pcs. (delivery on request)

for hinges in stainless steel (329266),
see page GY-323b (group 03)

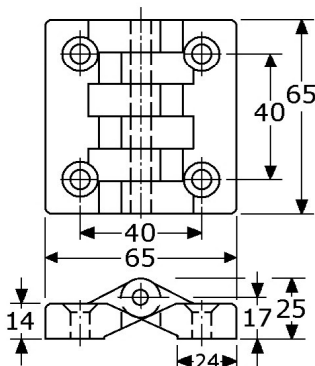

462980

hinges 65x65x14mm
black polyamide (PA)
with fixed stainless steel pin \varnothing 6mm
6-knuckles \varnothing 17mm, highness 25mm
no spring, no friction, maximum opening 180°
with 4 countersunk screwholes (6mm/M6)
in boxes of 20 Pcs. (delivery on request)

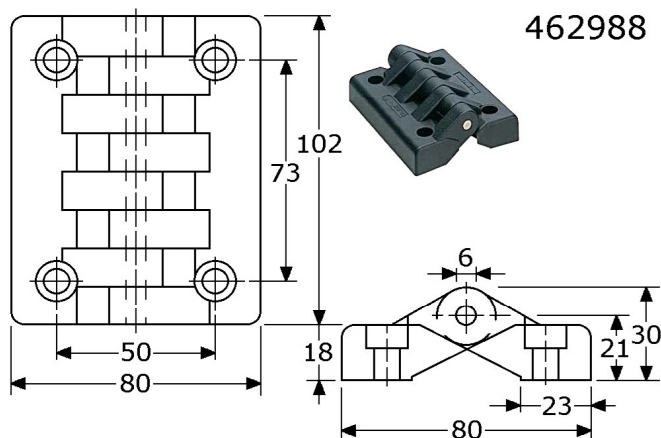

462988

hinges 80x102x18mm
black polyamide (PA)
with fixed stainless steel pin \varnothing 6mm
8-knuckles \varnothing 18mm, highness 30mm
no spring, no friction, maximum opening 180°
with 4 lower screwholes \varnothing 8,5mm
in boxes of 10 Pcs.



PIMEX B.V.
Coenecoop 131
2741 PJ WADDINXVEEN (NL)
Tel. (31) 182 - 61 11 66
Email: info@pimex.nl