

**LOCKS**

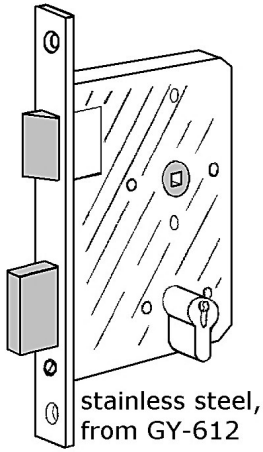

stainless steel, GY-630



stainless steel, from GY-612



stainless steel, GY-631

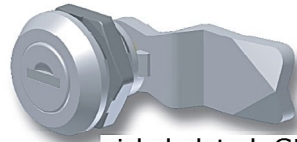

nickel plated, GF-662  
stainless steel, GY-647a

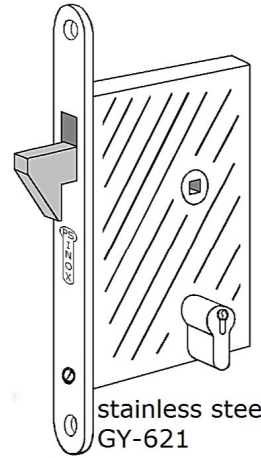

stainless steel, GY-621

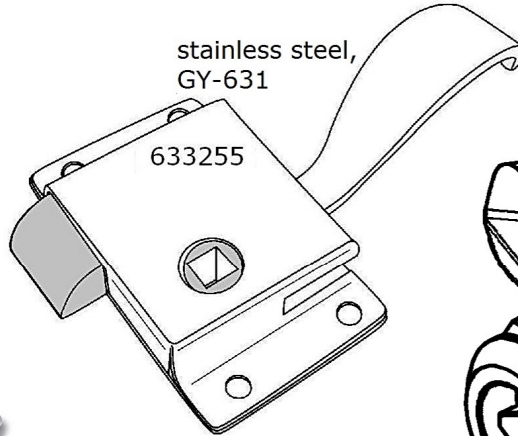

stainless steel, GY-631

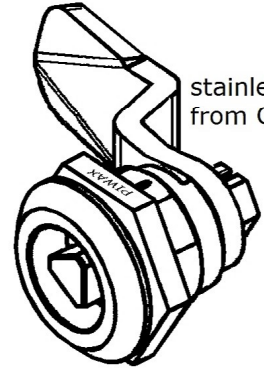

stainless steel, from GY-650a



stainless steel, GY-657a



stainless steel, GY-648b



stainless steel, GY-659a



stainless steel with compression, GY-653a



chrome or nickel plated, from GY-694



stainless steel, GY-618



stainless steel, from GY-689a

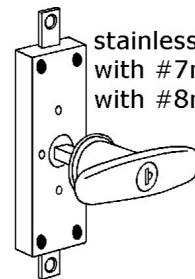

stainless steel, with #7mm from GY-680a with #8mm from GY-683a

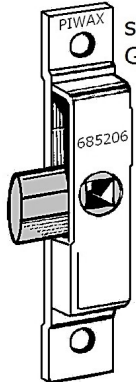

stainless steel, GY-686a

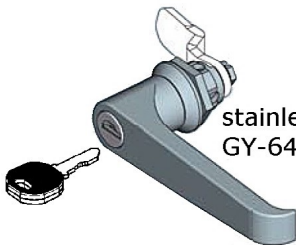

stainless steel, GY-647b



stainless steel, GY-648a



stainless steel, from GY-652a



stainless steel, from GY-698



stainless steel, GY-687d



nickel plated, GF-667



nickel plated, GF-666



stainless steel, from GY-687a

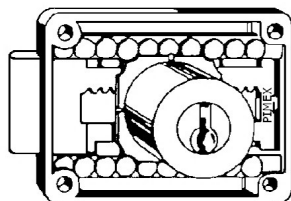

nickel plated, GF-666



**PIMEX B.V.**  
Coenecoop 131  
2741 PJ WADDINXVEEN (NL)  
Tel. (31) 182 - 61 11 66  
Email: info@pimex.nl