

860224

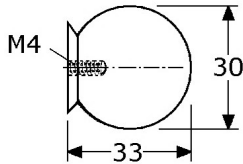

knobs $\varnothing 20\text{mm}$
stainless steel 304/A2 satin polished
massiv round type, highness 22mm
with small flange $\varnothing 16\text{mm}$
unvisible mounting from backside M4
in boxes of 25 Pcs.



860228



knobs $\varnothing 30\text{mm}$
stainless steel 304/A2 satin polished
massiv round type, highness 33mm
with small flange $\varnothing 24\text{mm}$
unvisible mounting from backside M4
in boxes of 25 Pcs.

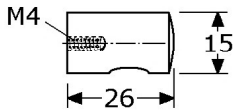

861270



knobs $\varnothing 15\text{mm}$
stainless steel 304/A2 satin polished
massiv long type, highness 26mm
with integrated finger grip
unvisible mounting from backside M4
in boxes of 25 Pcs.

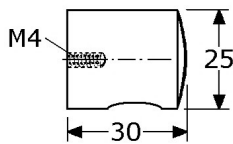

861276

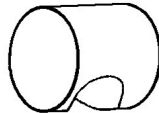

knobs $\varnothing 25\text{mm}$
stainless steel 304/A2 satin polished
massiv long type, highness 30mm
with integrated finger grip
unvisible mounting from backside M4
in boxes of 25 Pcs.

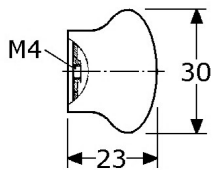

863213

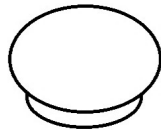

knobs $\varnothing 30\text{mm}$
stainless steel 304/A2 mirror polished
not massive, highness 23mm
no flange, nice finish
unvisible mounting from backside M4
in boxes of 20 Pcs.

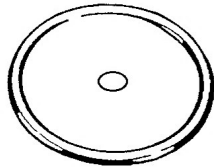

863221

roses (for knobs) $\varnothing 41\text{mm}$
stainless steel 304/A2 mirror polished
in boxes of 20 Pcs.
(also possible satin polished = 863220)

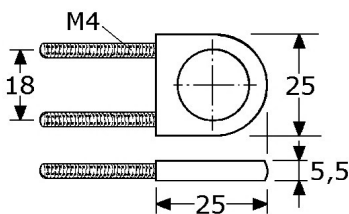

864251



knobs with eye inside $\varnothing 17\text{mm}$
stainless steel 304/A2 mirror polished
massiv, widthness 25mm, highness 25mm
unvisible mounting from backside M4
with 2x loose thread M4
in boxes of 20 Pcs.

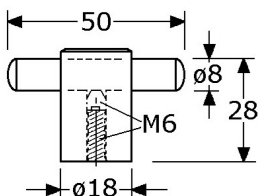

843266



PIWAX handle $\varnothing 8 \times 50\text{mm}$
stainless steel 316 satin polished
with 1 PIWAX base SS-316 $\varnothing 18\text{mm}$
total highness 28mm, handle length 50mm
flexible & adjustable ###
unvisible mounting from backside M6
first hexagon socket set screw M6, than screw M6
in boxes of 20 Pcs. (with hexagon socket set screws)



PIMEX has also modern knobs
in aluminium silver or gold,
see page GF-854



PIMEX B.V.
Coenecoop 131
2741 PJ WADDINXVEEN (NL)
Tel. (31) 182 - 61 11 66
Email: info@pimex.nl

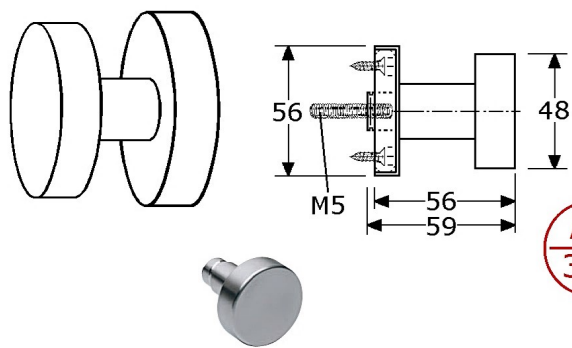

866221

door knob $\varnothing 48\text{mm}$ "cylinder" type
 stainless steel 316/A4 satin polished
 fixed single type, with anti-rotation pin
 with stainless steel 316/A4 rose $\varnothing 56 \times 8\text{mm}$
 unvisable mounting with black nylon underrose
 underrose with screwholes M4 c.t.c. 38mm
 mounting from backside with thread M5
 in boxes of 6 Pcs. (discontinued)

also possible:
 - stainless steel 304/A2 pair mounting

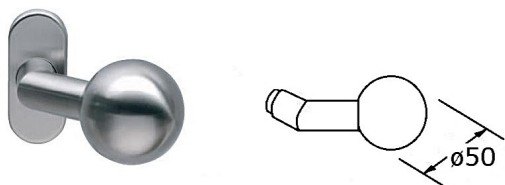
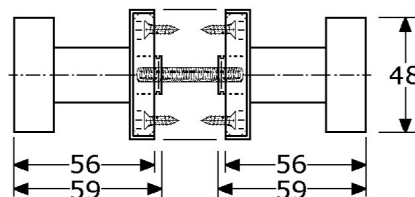

866272

door knob $\varnothing 50\text{mm}$ "ball cranked/cropped"
 stainless steel 304/A2 satin polished
 fixed single type, with anti-rotation pin
 with stainless steel 304/A2 rose $68 \times 30 \times 10\text{mm}$
 highness 95mm, widthness $\pm 83\text{mm}$
 unvisable mounting with black nylon underrose
 underrose with screwholes M4 c.t.c. 50mm
 mounting from backside with thread M5
 in boxes of 10 Pcs.

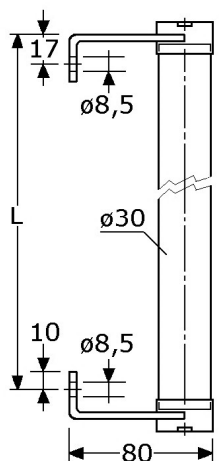

875238

end brackets for tube handles/rail $\varnothing 30 \times 1,5\text{mm}$
 stainless steel 304/A2 satin polished
 surface mounting, total highness 80mm
 mounting plate $27 \times 32\text{mm}$, no left or right
 fixing from side with hexagon socket head screw
 plate with 1x round screwhole $\varnothing 8,2\text{mm}$
 in boxes of 6 Pcs.
 (more information, see page GY-841)

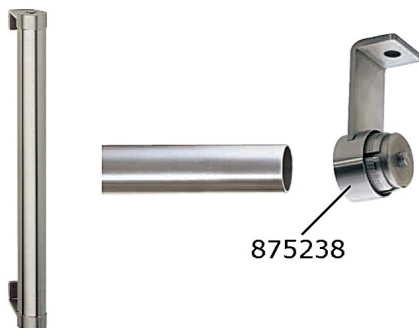

875238

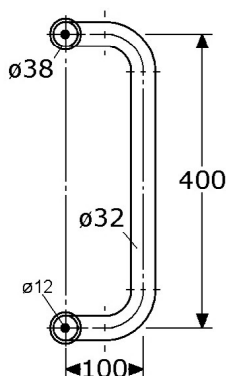
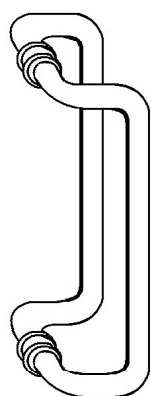

847294

tube door pull handle $\varnothing 32 \times 400\text{mm}$
 stainless steel 304/A2 satin polished
 total length 432mm, length centre-centre 400mm
 highness 106mm, hand opening $368 \times 74\text{mm}$
 cranked 100mm, with stainless steel roses $\varnothing 38\text{mm}$
 with black rubber roses $\varnothing 38 \times 2\text{mm}$ (for glass door)
 front: unvisable mounting for door 40-65mm
 back: with hexagon socket set screws
 pair mounting with stainless steel bolts M8x100
 ### cheap price, quick delivery ###
 in boxes of 1 pair



PIMEX B.V.
 Coenecoop 131
 2741 PJ WADDINXVEEN (NL)
 Tel. (31) 182 - 61 11 66
 Email: info@pimex.nl

LETTER PLATE, stainless steel

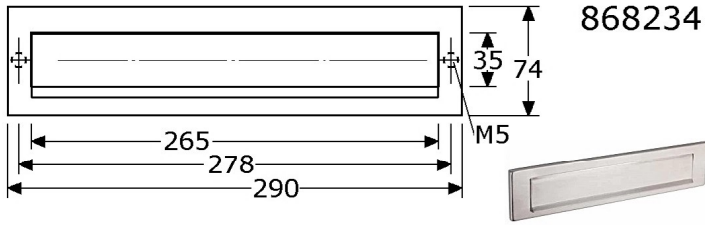

868234

letter plate for outward opening with hinged flap
stainless steel 304/A2 satin polished
outside 74x290mm, highness 8mm
with letter opening 35x265mm
unvisible mounting, without spring
with 2 nocks M5 c.t.c. 278mm
in boxes of 1 Pcs.

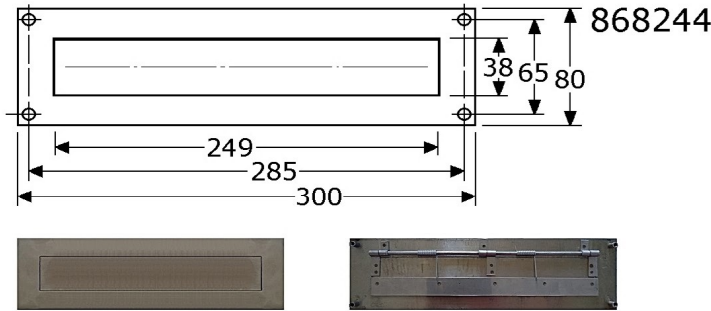

868244

letter plate for inward opening flap
stainless steel 304/A2 satin polished
outside 80x300mm, thickness 2mm
with small letter opening 38x249mm
unvisible mounting, with stainless steel spring
with 4 nocks M4 c.t.c. 65x285mm
in boxes of 1 Pcs.

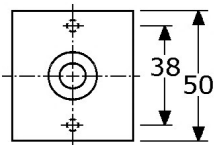

869204

bell push 50x50mm
stainless steel 304/A2 satin polished
with brass nickel button
with 2 countersunk screwholes
in boxes of 1 Pcs. (discontinued)

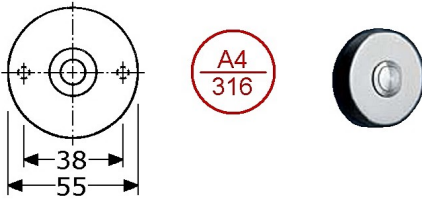

869205

bell push \varnothing 55x10mm
stainless steel 316/A4 satin polished
with stainless steel button
unvisible mounting with black underrose
underrose with countersunk screwholes
in boxes of 1 Pcs. (discontinued)

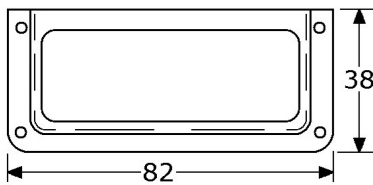

869233

label holder with opening from top
stainless steel mirror polished
outside 38x82mm, inside 25x65mm
with 4 small holes \varnothing 1,9mm
in boxes of 100 Pcs.



869236

label holder with opening from top
stainless steel satin polished
outside 50x100mm, inside 32x75mm
with 4 small holes \varnothing 1,9mm
in boxes of 100 Pcs.

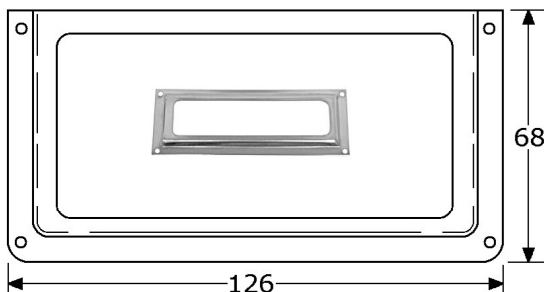

869238

label holder with opening from top
stainless steel satin polished
outside 68x126mm, inside 50x100mm
with 4 small holes \varnothing 1,9mm
in boxes of 100 Pcs.



PIMEX B.V.
Coenecoop 131
2741 PJ WADDINXVEEN (NL)
Tel. (31) 182 - 61 11 66
Email: info@pimex.nl